

Projekt domu Leda

autor: Marcin Abramowicz Agnieszka Ciborska
cena projektu: 5 140 zł

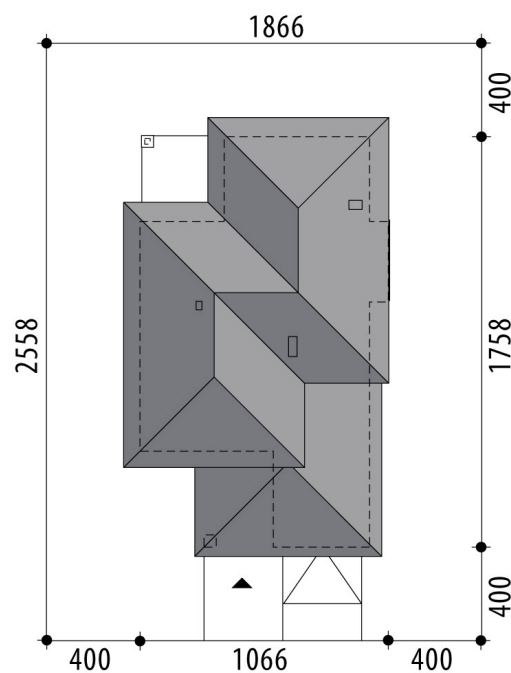

Powierzchnia użytkowa	157,80 m²
+ powierzchnia garażu	20,10 m²
+ powierzchnia pom. gosp.	5,30 m²
Powierzchnia zabudowy	164,70 m ²
Kubatura netto	571,40 m ³
Powierzchnia dachu skośnego	197,60 m ²
Kąt nachylenia dachu	30°
Wysokość budynku	8,30 m
Min. wymiary działki dł.	25,58 m
Min. wymiary działki szer.	18,66 m
Liczba pokoi	5
Liczba łazienek	2
Garaż	1



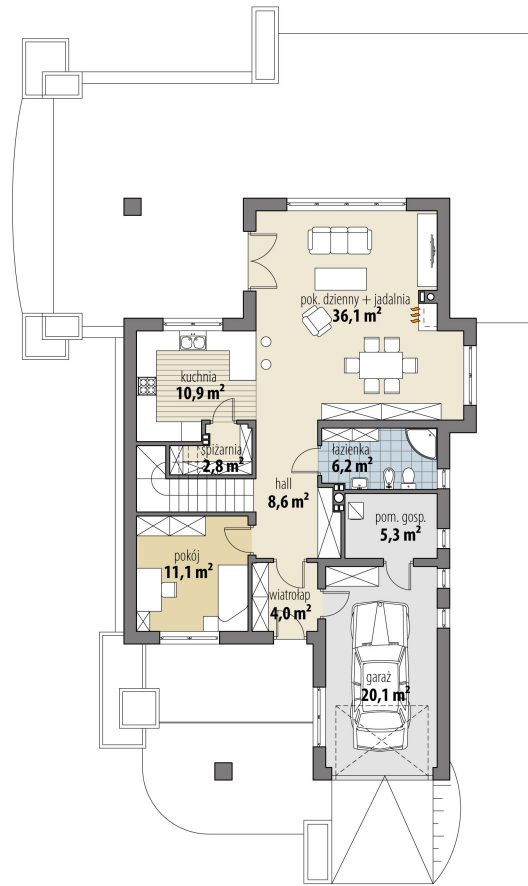

RZUT PARTER

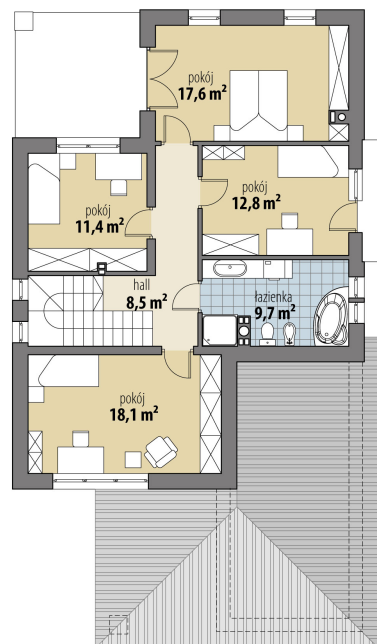

RZUT

